



Minimax

1430/1530/1630/1830



ENG
Serial no.: 100-XXX

Minimax

Type 1430/1530/1630/1830 cm

Congratulations on the purchase of your new Minimax. For **safety reasons** and to achieve optimum service from the product, please read the User Guide **before use**.

©Copyright 2010. All rights reserved, DAL-BO A/S

This product has:

Type no.: _____ Serial no.: _____
Month of manufacture: _____ Net weight kg: _____

If contacting the manufacturer regarding spare parts or service, please state type and serial number. A spare parts list is included at the back of this manual.

EU DECLARATION OF COMPLIANCE

DAL-BO A/S
DK-7183 Randbøl
+4575883500

declares herewith that the above machine is manufactured in accordance with the provisions of directive 2006/42/EC, which replaced directive 98/37/EC and change directives 91/368/ECC, 93/44/ECC and 93/68/ECC on harmonisation of member state legislation concerning health and safety requirements related to the construction and manufacture of machines.



This machine corresponds to the safety requirements in the European Safety Guidelines.

DAL-BO A/S

Date: _____

Managing Director Kaj Pedersen

Table of Contents

SAFETY	7
GENERAL	7
HYDRAULICS	8
ASSEMBLY	8
MAINTENANCE AND REPAIR	8
ROAD TRANSPORT	8
CORRECT USE	9
TECHNICAL DATA	10
HOW TO USE THIS MANUAL	11
DELIVERY	11
USES	12
CONNECTING AND DISCONNECTING	13
CONNECTING.....	13
HYDRAULICS	13
DISCONNECTION.....	14
SETTING UP	15
ADJUSTING DRAWBAR HEIGHT	15
ADJUSTING MID-SECTION	16
OPERATION	17
EXTENDING AND RETRACTING	17
<i>Extending</i>	17
<i>Retract</i>	18
ADJUSTMENT OF HYDRAULIC WEIGHT TRANSFER	20
<i>Excessive pressure</i>	20
<i>Insufficient pressure</i>	20
OPERATING SPEED	21
<i>Power</i>	21
TROUBLESHOOTING	22
MAINTENANCE	23
LUBRICATION	23
ADJUSTMENT.....	24
<i>Adjustment of rollers</i>	24
<i>Wheels</i>	24
HYDRAULICS	25
REPLACEMENT AND REPAIRS	26
HYDRAULICS	26

<i>Replacing fold/extend cylinder for side sections (inner)</i>	26
<i>Replacing gasket set for extend/retract cylinder</i>	27
<i>Assembly</i>	28
<i>Replacing raise/lower cylinder</i>	28
<i>Replacing gaskets on raise/lower cylinder</i>	29
<i>Assembly</i>	29
REMOVAL/FITTING WHEEL.....	30
<i>Replacing wheel bearings</i>	30
REMOVING ROLLER AXLES	31
<i>Replacing side section axles</i>	31
<i>Fitting axles with roller rings</i>	31
<i>Replacing the centre axle</i>	32
REPLACING AXLES, BEARINGS OR ROLLER RINGS.....	32
<i>Crosskill ring</i>	33
SCRAPPING	34
SPARE PARTS	35

Safety



This symbol appears in the instruction manual each time there is a safety warning concerning your safety, the safety of others or functionality of the machine. All safety instructions must be observed and made available to all users of the machine.

General

- Ensure you are familiar with all aspects of the machine before use
- There are safety stickers on the machine containing important instructions for the safety of yourself and others, and correct use of the machine.
- Do not carry passengers during operation or transport.
- Ensure there are no personnel within the machine's working radius before operating. Operate machine only from inside the tractor.
- When the machine is folded together, check the side sections are locked. Check all control handles are secured against accidental operation.
- Before leaving the tractor or making adjustments, performing maintenance or repairs on the roller, extend fully and lower to ground, or maintain in transport position, apply tractor handbrake, switch engine off and remove ignition key to secure the machine against accidental operation.
- Remember to secure support leg with hydraulic ball cock and pins with split rings.
- Never leave driver's seat whilst machine is moving.
- Always adapt speed to conditions.
- Do not use machine unless all safety devices are in place. Defective safety devices must be replaced immediately.

Hydraulics

- Lower machine fully for any repair work on the hydraulic system. Relieve hydraulic pressure, switch engine off and remove ignition key.
- Clean hydraulic connections thoroughly before reconnecting. When connecting hydraulic hoses to tractor hydraulics, ensure they are not under pressure.
- Bleed the hydraulic system thoroughly after any repairs.
- Check hydraulic hoses regularly for defects such as cracks, splits, crimps, wear or breaks. Defective hoses must be replaced immediately.
- Avoid spilling oil on the ground. If oil is spilt, collect and deliver to a destruction point.
- Clean hands thoroughly after contact with oil and grease. Change oil-stained clothing immediately. Hydraulic oil can be harmful to the skin.
- Hydraulic oil released under high pressure can penetrate the skin and cause severe injury. In the event of injury, seek medical help immediately.

Assembly

- Danger of crushing! Ensure no personnel are between implement and tractor, or between the parts to be connected.

Maintenance and repair

- Ensure machine is adequately supported or fully extended for all repair and maintenance work. Ensure tractor and machine are properly braked, engine stopped and ignition key removed.
- Tighten all screw connections after a few hours use. Check all screw connections regularly and tighten as required. Check all split pins and bolts to avoid mechanical failure.
- Dispose of oil, grease and filters in accordance with local environmental protection rules.

Road transport

- All safety and warning precautions mandatory by law must be fitted and tested before transporting the machine on public roads. The driver is responsible for correct lighting and warning signs in accordance with traffic regulations.

- Check with local traffic authorities whether transport on public roads is allowed given the machine's dimensions.
- When transporting, ensure permitted total weight for tractor is not exceeded and that loading on tractor front axle is not less than 20% of tractor net weight. If this is the case, use weights on tractor front

Correct use

- Correct use of the machine includes observing the manufacturer's operating, maintenance and repair instructions, and that original spare parts are always used.
- The roller may only be used, maintained or repaired by personnel familiar with it and who are aware of the risks that can be involved.
- The manufacturer cannot be held liable for injury or damage arising from modifications made to the machine performed without prior permission from the manufacturer. Neither can the manufacturer be held liable for injury or damage arising from incorrect use. Such liability rests solely with the user.
- Do not add extra weight to the machine.

Technical data

Minimax

Size (cm)	1430	1530	1630	1830
HP (recommended)	Min. 200	Min. 215	Min. 230	Min. 250
Gross weight kg:				
Cambridge/Breaker 50	8.440	8.675	8.880	9.820
Cambridge/Breaker Plus 50	8.610	8.855	9.075	10.040
Cambridge/Breaker 55	9.750	10.065	10.380	11.500
Cambridge/Breaker Plus 55	10.135	10.480	10.820	12.000
Crosskill 53	7.620	7.700	7.950	8.770
Crosskill 60	9.410	9.700	9.990	11.060
Sections (pcs.)	5	5	5	5
Hydraulic requirements:				
4 DV	X	X	X	X
Accessories				
Compressed air brakes	X	X	X	X

Wheels

All models: 600/50 x 22.5

The table below indicates the amount of oil which will return to the tractor when the roller is fully extended.

Model	Oil (litres)
1430/1530/1630	20
1830	16

How to use this manual

The sequence of subject matter in this manual can seem illogical. Please refer to the table of contents for page numbers for individual items.

The manual is divided into 5 main sections:

- Safety
- Starting routine and running
- Accessories
- Maintenance
- Repairs

The following symbols represent:



Points which are important to functionality and service life.



Points relevant to safety.

Delivery

The machine is delivered complete on a trailer.

If lifting the roller, we recommend the use of straps on the mid-section and drawbar to maintain balance.

Uses

Minimax is a heavy-duty roller designed to follow the surface of the earth optimally across its full width.

Minimax is a five-piece roller, on which the sections are independent of each other. Hydraulic weight transfer is standard on all models.

Fig. 1



Minimax 1630

Minimax is used after sowing to improve sprouting and compress stones. Minimax can also be used for breaking up a compressed soil surface in wheat fields or grassed areas.

Minimax can be fitted with compressed air brakes instead of the standard hydraulic brakes.

Connecting and disconnecting

Connecting

Connect roller to the tractor's fixed towbar, where drawbar (A) must fit between the towbar forks.

Insert the towbar pin, open support leg ball cock to raise the leg, secure ball cock when leg is fully raised.

Fig.2

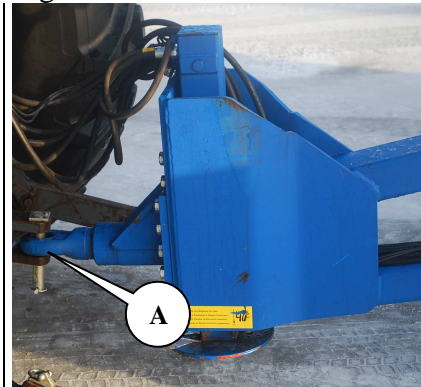

Remember to secure towbar pin with split pin or the like.

Hydraulics

Minimax 1430/1530/1630/1830 requires four double-action hydraulic outlets as standard, plus a hydraulic brake outlet.

Table 1. Hose markings

Cylinder name	Colour	Outlet	Function
Raise/lower cylinder	White	Double acting	Raises Minimax onto its wheels and down into working position.
Fold/Weight transfer of innermost side frames	Red	Double acting	Folds the inner side sections together/out, and acts as weight transfer from the mid-section to the inner side sections.
Fold/Weight transfer of outermost side frames	Black	Double acting	Folds the outer side sections together/out, and acts as weight transfer from the mid-section to the outer side sections.
Support leg	Yellow	Double acting	Raises/lowers the tow bar on the drum for coupling.
Brake hose	Black	Single acting	Brakes the roller wheels when tractor brake pedal is activated.



Flow setting is needed for the outlets for fold/weight transfer marked Red/Black, plus outlet for the raise/lower cylinder marked white.

Check hydraulic hoses for crimping

Disconnection

Open support leg ball cock to activate support leg outlet. Close ball cock, remove tow bar pin and disconnect hydraulic hoses.



Remember to depressurise hoses before disconnecting them.

Minimax must be in transport or working position when disconnecting.

Setting up

The machine is supplied with factory settings, but fine adjustment will always be required before use. Numerous adjustment options make the roller more flexible and ensure maximum use.

Adjusting drawbar height

To achieve uniform soil compression, the mid-section must be horizontal in the direction of travel when lowered and the tractor tow bar must be correctly positioned.

Before adjusting drawbar to tractor, basic setting must be correct. Put the roller on the support leg and check distance between flange underside and ground is 40 cm. Adjust drawbar to tractor from this basic position.

Fig. 3

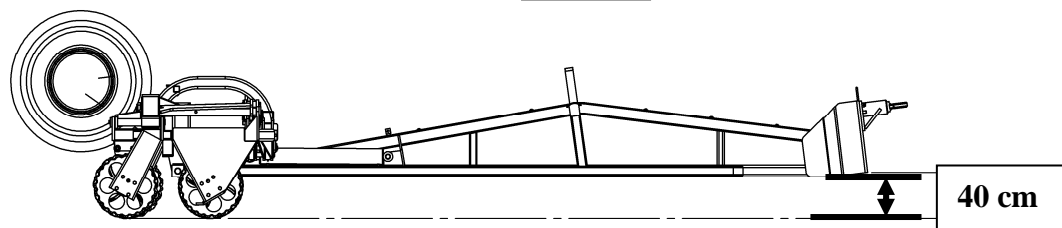
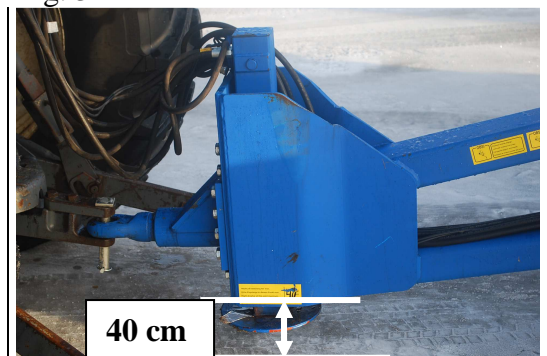

Incorrect drawbar height can cause uneven operation, as the roller will not apply equal pressure for all sections.

To achieve optimum drawbar height, the drawbar can be turned or adjusted up/down until the eye fits the tractor towbar.

Stand Minimax on support leg. Slacken bolts (A) and adjust drawbar to tractor.

Fig. 4

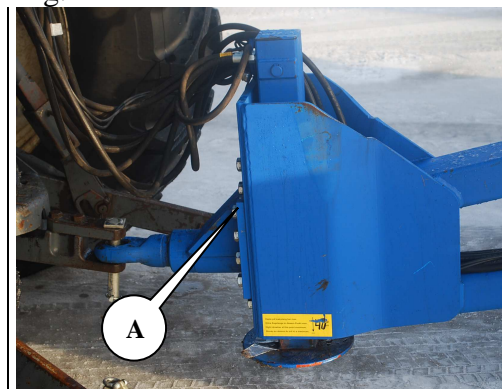

Adjusting mid-section

Fully extend roller on a level surface (see "Operation") check pipe (A) on mid-section is horizontal in direction of travel.

This must be done after the draw-bar is adjusted, and with Minimax attached to the tractor.

Fig. 5



Operation

Correct operation is vital for optimum use. This applies to working in the field and for safety. Always ensure you are fully familiar with all safety aspects of the machine.

Extending and retracting

Extending and retracting the machine must always be performed with tractor parked.

Extending

- 1 Lift side sections from transport hook (A) using raise/lower cylinder marked white (Fig. 6).

Fig. 6

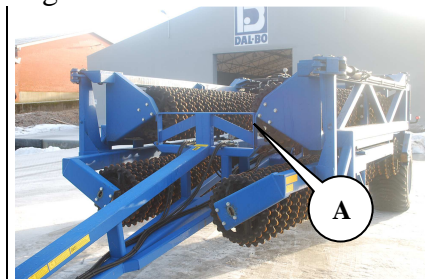

- 2 Activate cylinders marked red for extend/fold of innermost side frames and fully extend side sections. (Fig. 7)

Fig. 7



- 3 Activate cylinders marked black for extend/fold of outermost side frames and fully extend side sections. (Fig. 8)

Fig. 8



- 4 Activate raise/lower cylinder to lower roller to ground. Set raise/lower cylinder in flow position. (Fig. 9)

Fig. 9





Before starting rolling, ensure weight transfer is correctly adjusted (see "Adjustment of hydraulic weight transfer").

Retract

1. Activate fold/extend cylinders marked red and black so that the outermost side sections (A) and the outermost of the innermost side sections (B) are slightly raised. Both manometers must read 0 bar!

Fig. 10

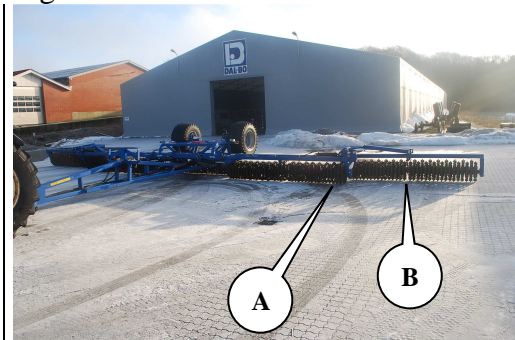

2. Activate raise/lower cylinders marked white to full length. Roller will lift from ground

Fig. 11



3. Activate fold/extend cylinders for the outermost side frames marked black again to fold these side sections fully in.

Fig. 12



4. Activate fold/extend cylinders for the innermost side frames marked black again to fold these side sections fully in.

Fig. 13



5. Lower the side frames into the transport hooks using the raise/lower cylinders marked white. When the transport hooks engage, set the hoses marked white into flow position!

Fig. 14



Adjustment of hydraulic weight transfer

Hydraulic weight transfer distributes the weight evenly between all roller sections.

1. Once the roller is fully extended and resting on the ground in working position, depressurise the fold/extend cylinders (marked: Red/Black). Activate the cylinder control handles in the opposite direction. Set the raise/lower cylinders marked white to flow position.

Fig. 15

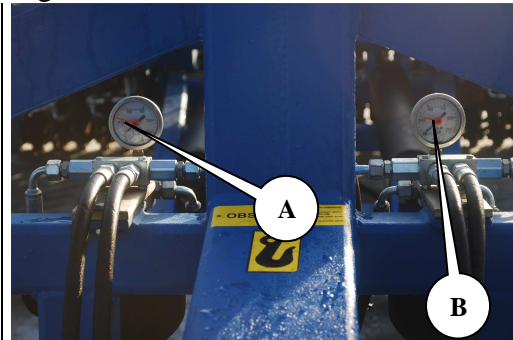

2. A fluctuation will occur on one of the manometers after a brief pause. Increase pressure to approx. 50 bar (A/B) on both manometers. This will transfer some of the mid-section weight to the side sections.

3. Set control handles for hoses marked red and black to flow position. Flow setting is necessary to achieve hydraulic weight transfer, allowing the sections to move independently
4. The pressure for hydraulic weight transfer may need adjustment. It can also be necessary to adjust pressure according to soil conditions.

Excessive pressure

1. The pressure on the outer rings of the innermost side sections will be too high. The rings will be pressed too heavily into the soil leaving a clear groove after the side sections. The pressure on the outer side sections will also be too high.
2. The mid-sections will not apply sufficient pressure, leaving the soil higher and not as compressed as the sides. The tractor tracks will also be deeper.

Insufficient pressure

1. The pressure on the outer rings of the inner side sections will be insufficient to give uniform compression. The pressure on the outer side sections will also be too low.
2. The mid-sections will compress too much, leaving the soil lower than the sides.



To prolong service life and the final result in the field, the hydraulic hoses marked white, red and black must be in flow setting when working in the field.



Failure to do so is incorrect use and can cause the frame to break in the worst scenario.

Operating speed

An operating speed of 6-10 km/h is recommended, but always operate according to conditions.

Increased speed will increase wear, particularly in dry conditions. The rings can also be damaged if operating at excessive speeds in unfavourable conditions.

Power

Power requirement will depend on soil type, terrain and speed.

Table 2, Guide to power requirement in HP

Model (cm)	1430	1530	1630	1830
HP	Min. 200	Min. 215	Min. 230	Min. 250

Troubleshooting

Fault	Cause	Remedy
Mid-section applying too much pressure	<ul style="list-style-type: none"> • Insufficient pressure transferred to side sections 	<ul style="list-style-type: none"> • Activate hydraulic control handle for extend/retract to increase pressure to side sections (see "Operation").
	<ul style="list-style-type: none"> • Drawbar too high 	<ul style="list-style-type: none"> • Adjust drawbar and mid-section (see "Adjusting drawbar height" and "Adjusting mid-section")
	<ul style="list-style-type: none"> • Mid-section not horizontal 	<ul style="list-style-type: none"> • Adjust drawbar and mid-section (see "Adjusting drawbar height" and "Adjusting mid-section")
Side section extremities applying too much pressure	<ul style="list-style-type: none"> • Insufficient pressure in mid-section 	<ul style="list-style-type: none"> • Activate hydraulic control handle for extend/retract to increase pressure to mid-section (see "Operation").
	<ul style="list-style-type: none"> • Drawbar too low 	<ul style="list-style-type: none"> • Adjust drawbar and mid-section (see "Adjusting drawbar height" and "Adjusting mid-section")
	<ul style="list-style-type: none"> • Mid-section not horizontal 	<ul style="list-style-type: none"> • Adjust drawbar and mid-section (see "Adjusting drawbar height" and "Adjusting mid-section")
Pressure on manometer dropping	<ul style="list-style-type: none"> • Handle not in flow setting 	<ul style="list-style-type: none"> • Adjust pressure on weight transfer and set handle to flow setting (see "Adjustment of hydraulic weight transfer")
	<ul style="list-style-type: none"> • Driver-operated non-return valve defective • Cylinder (gasket set) leaking 	<ul style="list-style-type: none"> • Set weight transfer to approx. 50 bar and set handle in flow setting. Leave Minimax standing for 30 mins. If pressure drops, the driver-operated non-return valve is defective, or there may be dirt in the valve (disassemble valve and clean parts or replace the valve)
Side sections not following terrain	<ul style="list-style-type: none"> • Weight transfer hydraulic system not in flow setting 	<ul style="list-style-type: none"> • Set hydraulic weight transfer in flow setting (see "Adjustment of hydraulic weight transfer")

Maintenance

Good maintenance ensures long service life and optimum use. Grease nipples are fitted where wear is heaviest.



Tighten all screw connections after first working day. Check all split pins and bolts to avoid mechanical failure. Check hydraulic system for leaks.

Lubrication

Fig. 16

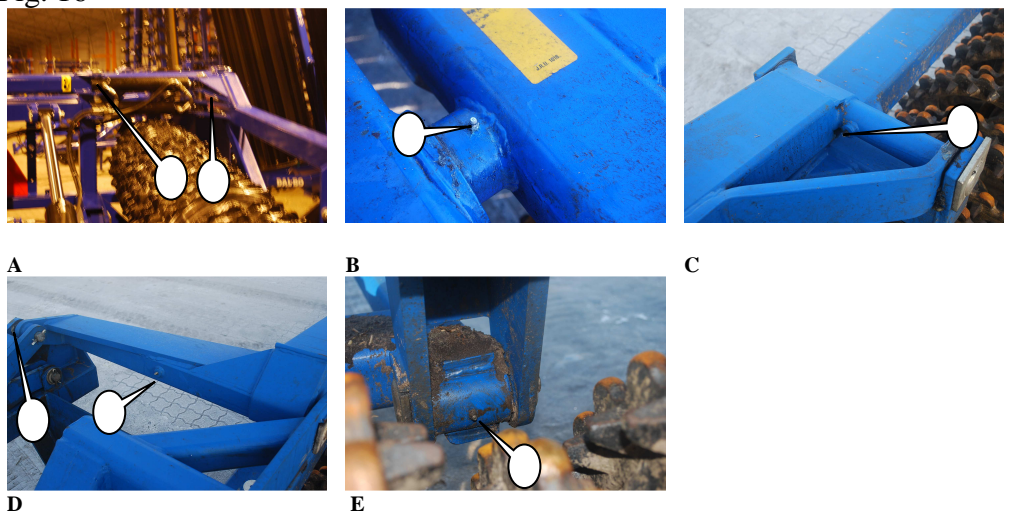

Lubrication points	Number of nipples	Lubrication intervals, hours	Illustration
Cylinder for extending side sections	8	50	A
Rotation pin for extending side sections	4	50	B
Outer outrigger arm	2	50	C
Inner outrigger arm	4	50	D
Drawbar/main frame	2	50	E



Lubricate all lubrication points at least once annually.

Adjustment

Adjustment of rollers

After the first season, the rollers will have loosened on the shaft. Play can be eliminated by moving the stop rings on the shaft.

Adjustment is easiest when Minimax is folded together.

Fig. 17

1. Slacken bolts (A) and push rollers together
2. Tighten and slacken stop ring bolts at the same place on the shaft several times to ensure they bite firmly into the shaft.

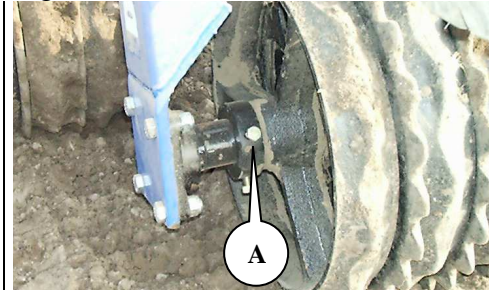

Wheels

Lubricate and adjust wheel bearings at least once annually. Check tyre pressures (see recommended pressure on tyre).

Adjustment and lubrication of wheel bearings

1. Remove hub caps.
2. Remove split pin.
3. Tighten castle nut 1/6th of a turn until hole aligns with axle. Turn wheel, check for resistance. A little play should be detected in the hub housing when rocking wheel from side to side. If play is excessive, repeat process.
4. Replace split pin
5. Fill hub cap $\frac{3}{4}$ full with grease. Replace.

Hydraulics



Check all hydraulic hoses for wear or cracks. Check all hoses for crimping.



Lubricate exposed rams with oil or pressure-resistant grease to avoid rust forming when storing for long periods. Remember to remove before use.

Replacement and repairs



Safety is vital for **all** repair work on the roller. Always observe the following points, plus those under Safety First in the instruction manual.



All maintenance and repair work can only be performed when the machine is lowered to the ground or locked in transport position, tractor is braked, engine stopped and ignition key removed to prevent accidental start.



Particular attention must be paid to safety when repairing hydraulics. Before commencing work, depressurise hydraulic system and support part being worked on.



Always ensure hydraulic system is bled after repairs and before use to prevent mechanical breakdown and injury to person.

Hydraulics

Replacing fold/extend cylinder for side sections (inner)

Perform repairs with Minimax fully extended and resting on the ground in working or transport position.

1. Depressurise cylinders. **Check there is no pressure shown on the manometer**
2. Disconnect hoses.
3. Remove split pins and pins. Cylinder will now be free.
4. Fit new or repaired cylinder. Check pin locks into place, secure pins with split pins.
5. Connect hoses. Check there is no danger of hoses being ripped or crimped after fitting.

Fig. 18





Activate extend/retract cylinders after fitting until they show a little movement. Reverse cylinders until they return to start position. Move cylinders backwards and forward several times. Raise roller fully onto wheels, extend side sections fully to bleed system.



Ensure no personnel are within the extension radius of the side sections.

Replacing gasket set for extend/retract cylinder

Fig. 19

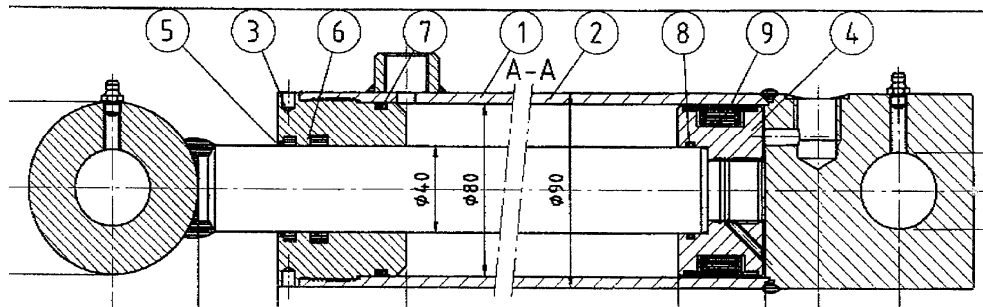

1. For cylinder removal, see "Replacing fold/extend cylinder for side sections".
2. Drain oil from cylinder by moving ram carefully backwards and forwards.
3. Extend ram to centre position. Unscrew upper part (pos. 3) from cylinder tube (pos. 1). Use special tool to remove upper part. If upper part is stuck, heat front of sleeve. When upper part is detached from cylinder tube, pull ram up towards upper part and remove completely from cylinder tube.
4. Remove lock nut retaining collar shoe (pos. 4).
5. Remove collar shoe (pos. 4) from ram.
6. Remove upper part (pos. 3) from ram.
7. Remove gaskets in upper part and collar shoe, (pos. 5+6+7+8+9).
8. Clean all parts and check for particles etc. Check for rust around scraper ring (pos. 5) in upper part. If detected, remove thoroughly.

Assembly

1. Fit new gaskets (pos. 5+6+7+8+9) in upper part and collar shoe. Remember to check gaskets are facing the right way.
2. Lubricate thread in upper part (pos. 3) and cylinder tube with oil.
3. Remove upper part (pos. 3) on ram shaft.
4. Remove collar shoe (pos. 4) and screw on lock nut, **secure with Loctite**. Ensure that thread is absolutely clean and free of oil or other impurities before applying Loctite. **Do not fill with oil for 12 hours after use of Loctite.**
5. Lubricate outer collar shoe gasket in contact with cylinder tube and inside of cylinder tube with oil, push ram into centre position.
6. Fit upper part onto cylinder tube and tighten.
7. Fit cylinder (see "Replacing fold/extend cylinder for side sections").

Replacing raise/lower cylinder

Fold Minimax out or leave in transport position. Depressurise raise/lower cylinder (A).

Fig. 20

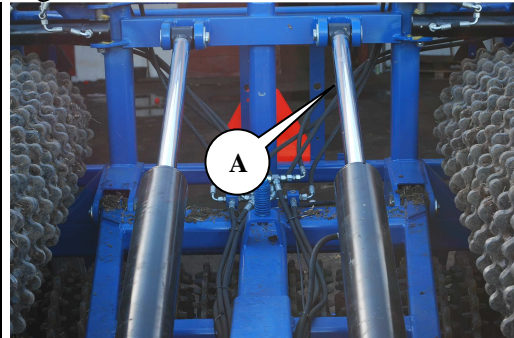

1. Disconnect hoses from cylinder
2. Support cylinder
3. Remove split pins in pins, remove pins
4. Remove cylinder
5. Fit new or repaired cylinder



Activate raise/lower cylinder after fitting until cylinder shows movement. Reverse cylinder until it returns to start position. Move cylinder backwards and forwards several times. Fully extend cylinder several times to bleed system.



Ensure no personnel are within the extension radius of the side sections.

Replacing gaskets on raise/lower cylinder

Fig. 21

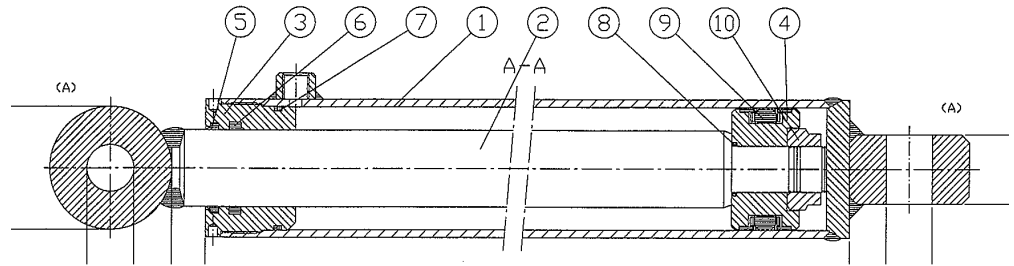

1. Drain oil from cylinder by moving ram carefully backwards and forwards.
2. Extend ram to centre position. Unscrew upper part (pos. 3) from cylinder tube (pos. 1). Use special tool to remove upper part. If upper part is stuck, heat front of upper part. When upper part is detached from cylinder tube, pull ram up towards upper part and remove completely from cylinder tube (pos. 1).
3. Remove lock nut (pos. 10) retaining collar shoe (pos. 4).
4. Remove collar shoe (pos. 4) from ram, (pos. 2).
5. Remove upper part (pos. 3) from ram, (pos. 2).
6. Remove gaskets in upper part (pos. 5+6+7+8+9) along with collar shoe.
7. Clean all parts and check for particles etc. Check for rust around scraper ring (pos. 5) in upper part. If detected, remove thoroughly.

Assembly

1. Fit new gaskets (pos. 5+6+7+8+9) in upper part, plus collar shoe.
2. Lubricate thread in upper part (pos. 3) and cylinder tube (pos. 1) with oil.
3. Remove upper part (pos. 3) on ram shaft.
4. Remove collar shoe (pos. 4) and screw on lock nut, **secure with Loctite**. Ensure that thread is absolutely clean and free of oil or other impurities before applying Loctite. **Do not fill with oil for 12 hours after use of Loctite.**
5. Lubricate outer collar shoe gasket in contact with cylinder tube and inside of cylinder tube with oil, push ram into centre position.
6. Fit upper part onto cylinder tube and tighten.
7. For fitting cylinder see "Replacing raise/lower cylinder".

Removal/fitting wheel

Before removing wheel, fully extend roller with rings resting on ground. Wheels will then be raised free of ground.

Remove wheel nuts. Remove wheel. Replace wheel, hand-tighten wheel nuts. Lower wheels to ground. Tighten wheel nuts to 300 Nm.



Ensure wheel nuts and wheel surfaces are clean to avoid nuts loosening.

Replacing wheel bearings

1. Remove hub cap pos. 21.
2. Remove split pin pos. 20.
3. Remove castle nut pos. 19.
4. Hub housing can now be removed from shaft.
5. Remove bearings pos. 17+18.
6. Fit seal ring pos. 16.

Fig. 22

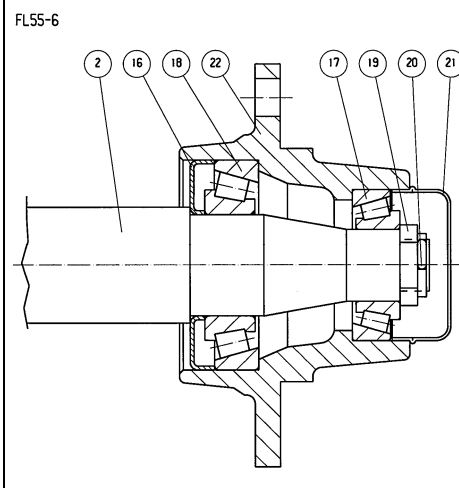

Assembly

1. Fit bearing outer rings pos. 17+18 in hub housing pos. 22
2. Remove seal ring pos. 16.
3. Fit bearing inner ring pos. 18 on axle pos. 2 and fit axle in hub housing
4. Fit bearing inner ring pos. 17 on axle pos. 2
5. Screw castle nut onto axle pos 2, whilst turning hub housing pos. 22. Tighten castle nut until hub housing revolves slowly. Slacken castle nut a quarter turn or until hub housing revolves easily.
6. Remove split pin pos. 20.
7. Fill hub cap pos. 21 half full with ball bearing grease and fit to hub

Removing roller axles

Repairs must be performed with the roller connected to a tractor, resting on a level surface, fully extended with the rings resting on the ground. A crane or similar is recommended for removal and replacement procedures.

Replacing side section axles

If no crane is available, remove both side section axles to prevent roller tipping over.



1. Slacken bolts (A)
2. Attach lifting gear to box section arm on side section. Tighten straps until bolts (A) are loose and can be removed.
3. Activate raise/lower cylinder, lift roller onto wheels
4. Roll axle with roller rings from roller.

Fig. 23



If there is no crane available, activate roller weight transfer a little until bolts are loose and can be removed.

Fitting axles with roller rings

1. Position axles with roller rings and bearings corresponding to that when Minimax is extended, resting on the ground.
2. Extend roller and carefully lower over the axles.
3. Fit bolts (A)



Ensure no personnel are within the machine's extension radius when activating hydraulics.

Replacing the centre axle

1. Slacken bolts (A)
2. Activate raise/lower cylinder and lower roller until wheels are resting on ground and bolts are loose.
3. Remove bolts
4. Raise roller until wheels are resting on the ground again and axle is free.
5. Roll axle with roller rings from roller.
6. Reverse procedure for assembly

Fig. 24

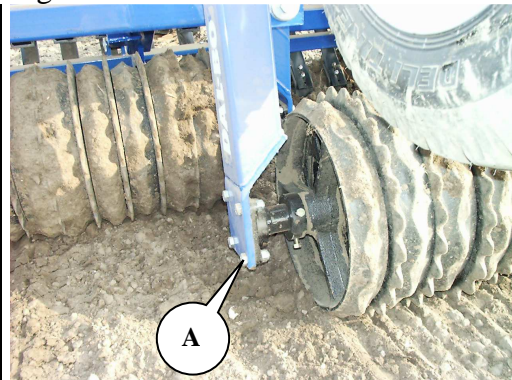

Do not activate hydraulics if there are personnel within machine extension radius.

Replacing axles, bearings or roller rings

1. Slacken bearing screws (A) and withdraw bearings
2. Slacken stop ring bolts (B) and withdraw stop rings.
3. Withdraw roller rings from axle
4. Reverse order to reassemble
5. Apply Loctite to bearing screws

Fig. 25

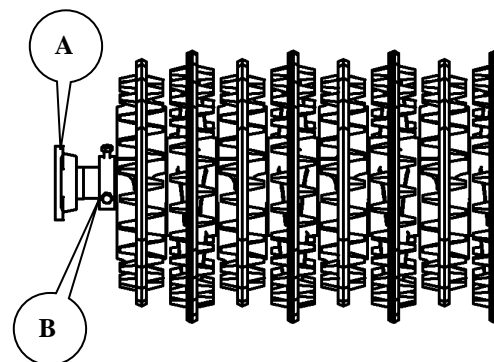

Crosskill ring

Note axle direction of rotation.

1. Start with a small ring after the outermost stop ring (Fig. , B).
2. Fit bushing (A)
3. Fit large ring (B)
4. Finish off with a small ring, and then fit a stop ring.

Fig. 26

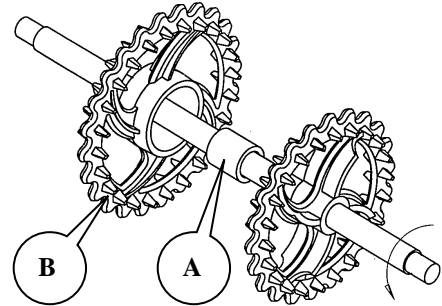

Tighten and slacken stop ring bolts a few times to ensure they bite into the axle



When fitting axles with bearings, remember to ensure the bearing lubrication nipples face backwards/upwards. This gives easy access for lubrication and protects the nipples from stones.



Check that the roller rings are close together and the direction of rotation for the Crosskill rings. Always finish with the small rings (smallest hole) at the axle ends (see "Spare part drawings")

Scrapping



Fully extend roller. It is essential that **all** cylinders are removed.



Beware of the weight of any given part when removing or disassembling. All parts **must** be supported or lifted to avoid danger of falling.

Disconnect hydraulic hoses and cylinders and drain oil. Collect oil in container to avoid pollution. Send oil and hoses for destruction.

All iron used in the machine can be recycled.

Spare parts